

### FAST RECOVERY DIODES

### Hockey Puk Version

#### Features

- High power FAST recovery diode series
- 4.5  $\mu$ s recovery time
- High voltage ratings up to 4500V
- High current capability
- Optimized turn on and turn off characteristics
- Low forward recovery
- Fast and soft reverse recovery
- Press-puk encapsulation
- Case style conform to JEDEC DO-200AB (B-PUK)
- Maximum junction temperature 125°C

#### Typical Applications

- Snubber diode for GTO
- High voltage free-wheeling diode
- Fast recovery rectifier applications

375A

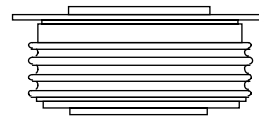

case style DO-200AB (B-PUK)

#### Major Ratings and Characteristics

Parameters	SD263C..S50L	Units
$I_{F(AV)}$	375	A
@ $T_{hs}$	55	°C
$I_{F(RMS)}$	408	A
$I_{FSM}$ @ 50Hz	5500	A
@ 60Hz	5760	A
$V_{RRM}$ range	3000 to 4500	V
$t_{rr}$	4.5	$\mu$ s
@ $T_J$	125	°C
$T_J$	- 40 to 125	°C

## SD263C..S50L Series

Bulletin I2071 rev.B 04/00

International  
IRF Rectifier

### ELECTRICAL SPECIFICATIONS

#### Voltage Ratings

Type number	Voltage Code	$V_{RRM}$ , maximum repetitive peak reverse voltage V	$V_{RSM}$ , maximum non-repetitive peak rev. voltage V	$I_{RRM}$ max. @ $T_J = T_J$ max. mA
SD263C..S50L	30	3000	3100	50
	36	3600	3700	
	40	4000	4100	
	45	4500	4600	

#### Forward Conduction

Parameter	SD263C..S50L	Units	Conditions
$I_{F(AV)}$ Max. average forward current @ Heatsink temperature	375 (150)	A	180° conduction, half sine wave Double side (single side) cooled
	55 (85)	°C	
$I_{F(RMS)}$ Max. RMS forward current	725	A	@ 25°C heatsink temperature double side cooled
$I_{FSM}$ Max. peak, one-cycle forward, non-repetitive surge current	5500	A	t = 10ms No voltage
	5760		t = 8.3ms reapplied
	4630		t = 10ms 50% $V_{RRM}$
	4850		t = 8.3ms reapplied
$I^2t$ Maximum $I^2t$ for fusing	151	KA <sup>2</sup> s	t = 10ms No voltage
	138		t = 8.3ms reapplied
	107		t = 10ms 50% $V_{RRM}$
	98		t = 8.3ms reapplied
$I^2\sqrt{t}$ Maximum $I^2\sqrt{t}$ for fusing	1510	KA <sup>2</sup> /s	t = 0.1 to 10ms, no voltage reapplied
$V_{F(TO)1}$ Low level value of threshold voltage	1.56	V	(16.7% x $\pi$ x $I_{F(AV)}$ ) < I < $\pi$ x $I_{F(AV)}$ , $T_J = T_J$ max.
$V_{F(TO)2}$ High level value of threshold voltage	1.71		(I > $\pi$ x $I_{F(AV)}$ ), $T_J = T_J$ max.
$r_{f1}$ Low level value of forward slope resistance	1.64	m $\Omega$	(16.7% x $\pi$ x $I_{F(AV)}$ ) < I < $\pi$ x $I_{F(AV)}$ , $T_J = T_J$ max.
$r_{f2}$ High level value of forward slope resistance	1.53		(I > $\pi$ x $I_{F(AV)}$ ), $T_J = T_J$ max.
$V_{FM}$ Max. forward voltage drop	3.20	V	$I_{pk} = 1000A$ , $T_J = T_J$ max, $t_p = 10ms$ sinusoidal wave

#### Recovery Characteristics

Code	$T_J = 25^\circ\text{C}$ typical $t_{rr}$ @ 25% $I_{RRM}$ ( $\mu\text{s}$ )	Test conditions			Max. values @ $T_J = 125^\circ\text{C}$			
		$I_{pk}$ Square Pulse (A)	di/dt (*) (A/ $\mu\text{s}$ )	$V_r$ (V)	$t_{rr}$ @ 25% $I_{RRM}$ ( $\mu\text{s}$ )	$Q_{rr}$ ( $\mu\text{C}$ )	$I_{rr}$ (A)	
S50	5.0	1000	100	-50	4.5	680	240	

(\*) di/dt = 25A/ $\mu\text{s}$  @  $T_J = 25^\circ\text{C}$

**Thermal and Mechanical Specifications**

Parameter	SD263C..S50L	Units	Conditions
T <sub>J</sub> Max. junction operating temperature range	-40 to 125	°C	
T <sub>stg</sub> Max. storage temperature range	-40 to 150		
R <sub>thJ-hs</sub> Max. thermal resistance, junction to heatsink	0.11 0.05	K/W	DC operation single side cooled DC operation double side cooled
F Mounting force, ± 10%	9800 (1000)	N (Kg)	
wt Approximate weight	230	g	
Case style	DO-200AB (B-PUK)		See outline table

**ΔR<sub>thJ-hs</sub> Conduction**

(The following table shows the increment of thermal resistance R<sub>thJ-hs</sub> when devices operate at different conduction angles than DC)

Conduction angle	Sinusoidal conduction		Rectangular conduction		Units	Conditions
	Single Side	Double Side	Single Side	Double Side		
180°	0.012	0.011	0.008	0.008	K/W	T <sub>J</sub> = T <sub>J</sub> max.
120°	0.014	0.015	0.014	0.014		
90°	0.018	0.018	0.019	0.019		
60°	0.026	0.027	0.027	0.028		
30°	0.045	0.046	0.046	0.046		

**Ordering Information Table**

**Device Code**

<b>SD</b>	<b>26</b>	<b>3</b>	<b>C</b>	<b>45</b>	<b>S50</b>	<b>L</b>
①	②	③	④	⑤	⑥	⑦

- 1** - Diode
- 2** - Essential part number
- 3** - 3 = Fast recovery
- 4** - C = Ceramic Puk
- 5** - Voltage code: Code x 100 = V<sub>RRM</sub> (See Voltage Ratings table)
- 6** - t<sub>rr</sub> code
- 7** - L = Puk Case DO-200AB (B-PUK)

# SD263C..S50L Series

Bulletin I2071 rev. B 04/00

International  
**IRF** Rectifier

## Outline Table

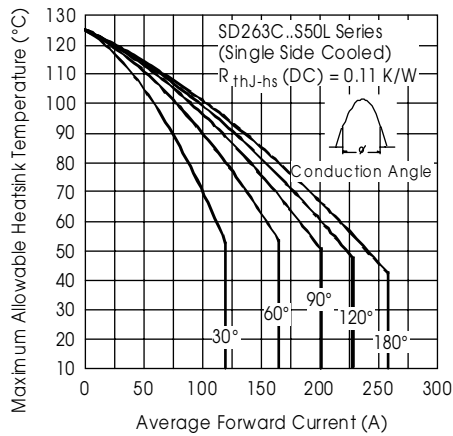
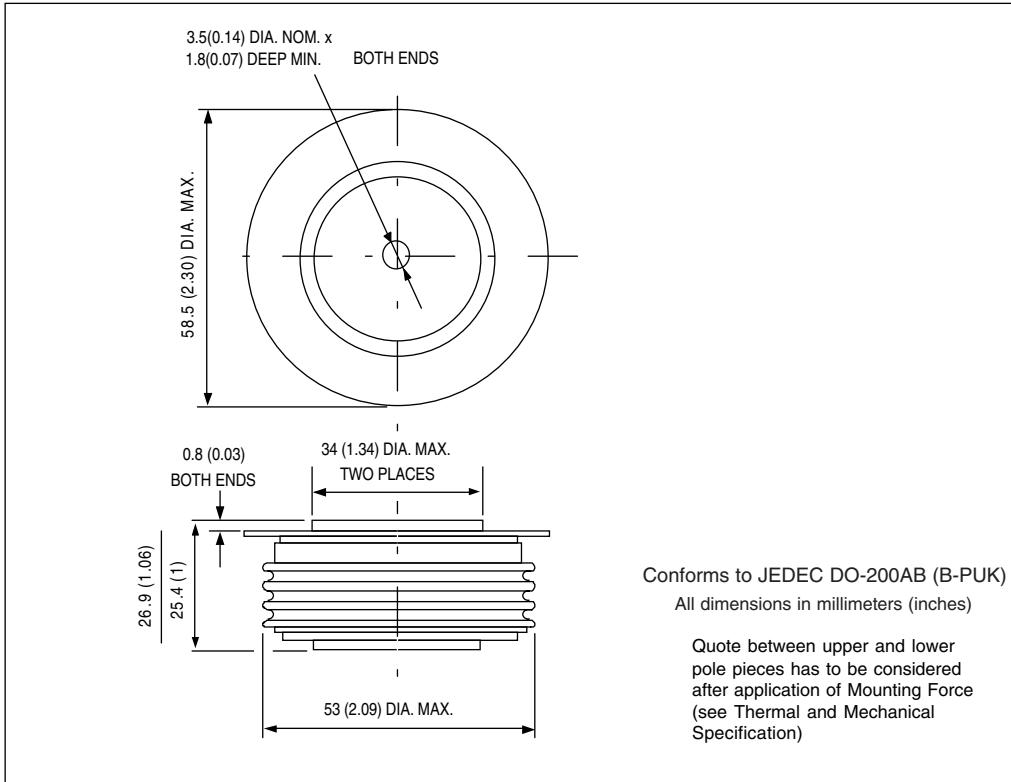

Fig. 1 - Current Ratings Characteristics

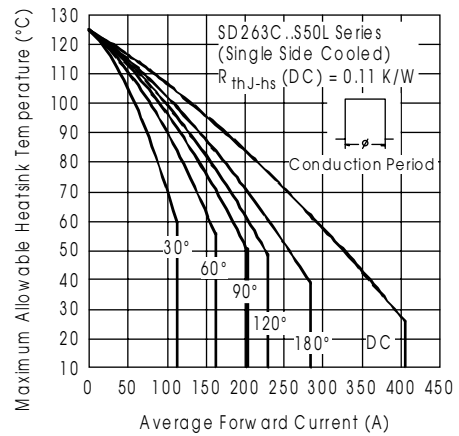

Fig. 2 - Current Ratings Characteristics

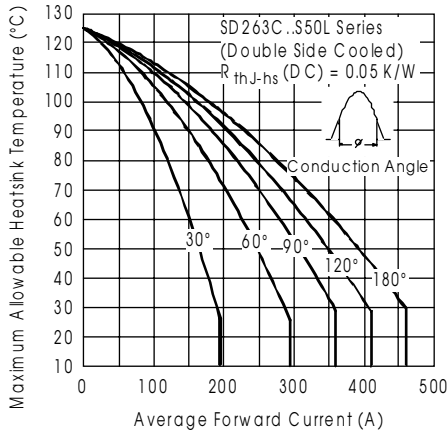

Fig. 3 - Current Ratings Characteristics

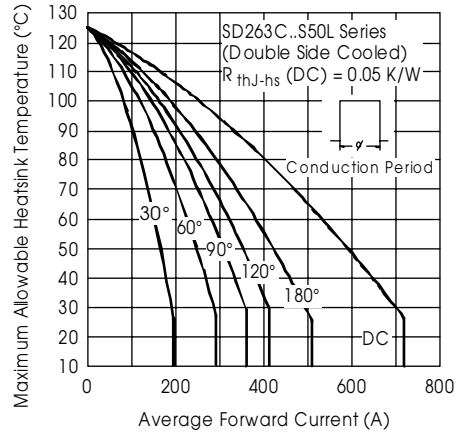

Fig. 4 - Current Ratings Characteristics

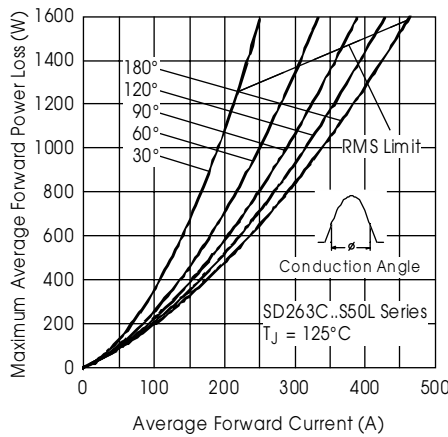

Fig. 5 - Forward Power Loss Characteristics

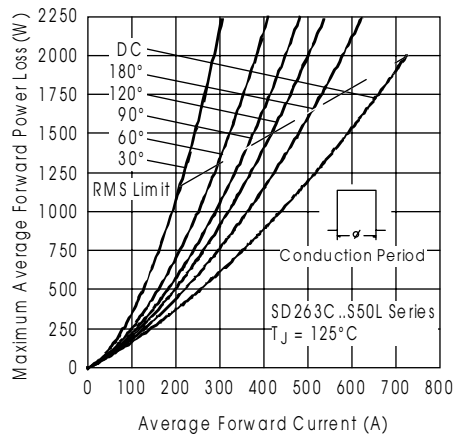

Fig. 6 - Forward Power Loss Characteristics

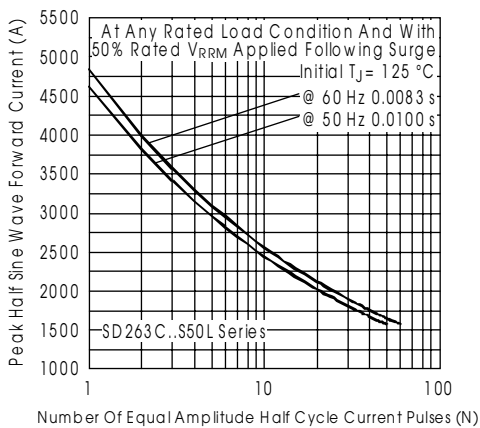

Fig. 7 - Maximum Non-repetitive Surge Current  
Single and Double Side Cooled

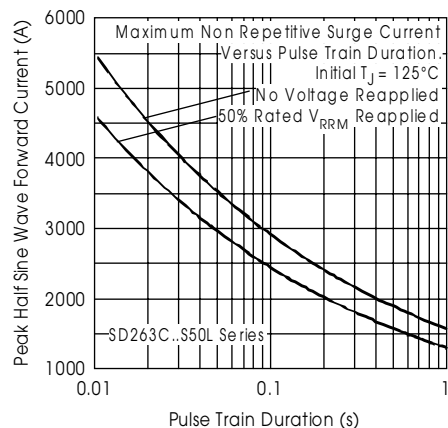

Fig. 8 - Maximum Non-repetitive Surge Current  
Single and Double Side Cooled

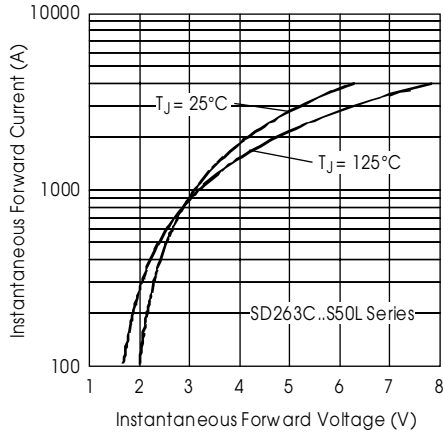

Fig. 9 - Forward Voltage Drop Characteristics

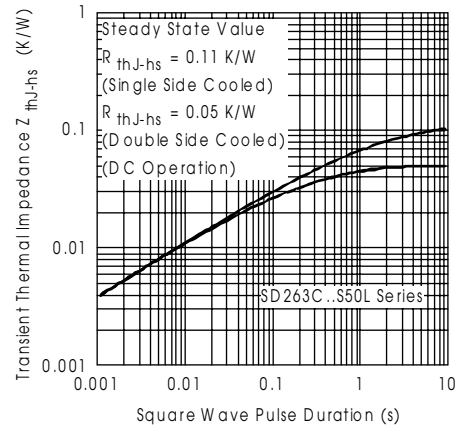

Fig. 10 - Thermal Impedance  $Z_{thj-hs}$  Characteristic

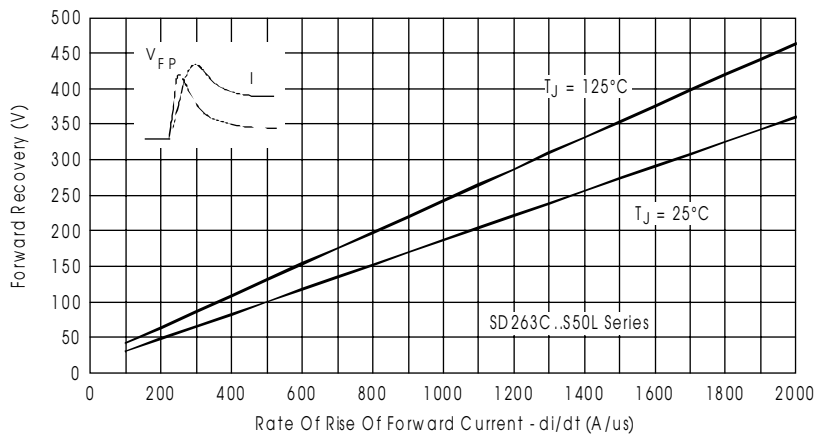

Fig. 11 - Typical Forward Recovery Characteristics

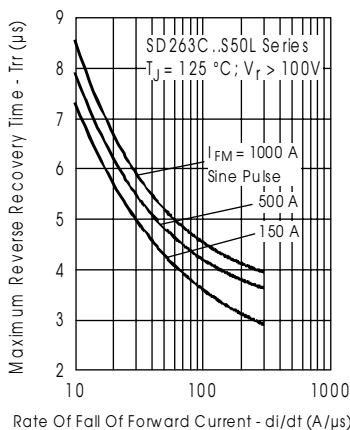

Fig. 12 - Recovery Time Characteristics

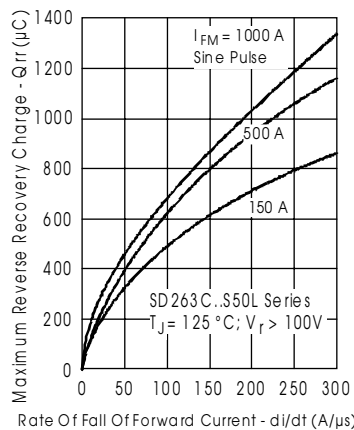

Fig. 13 - Recovery Charge Characteristics

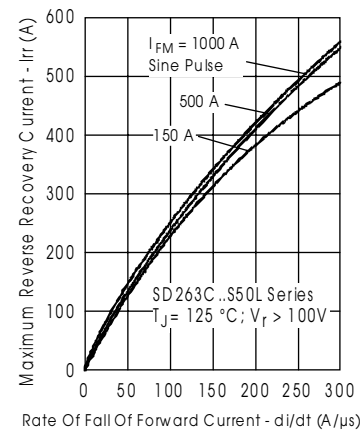

Fig. 14 - Recovery Current Characteristics

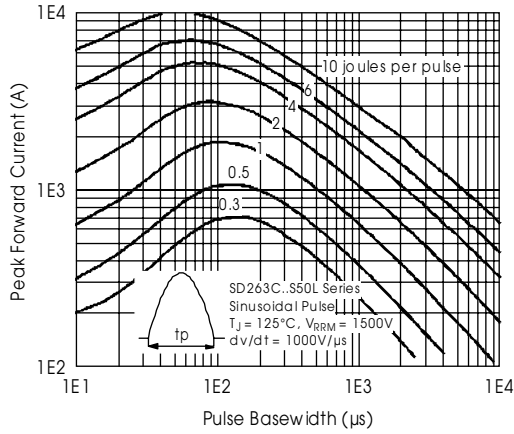

Fig. 15 - Maximum Total Energy Loss Per Pulse Characteristics

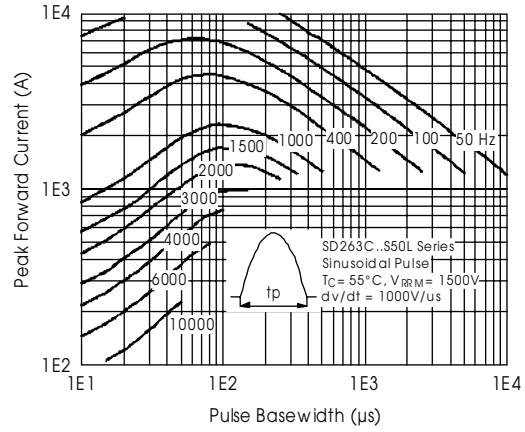

Fig. 16 - Frequency Characteristics

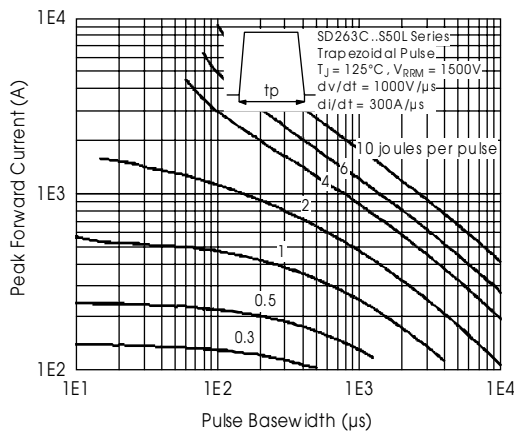

Fig. 17 - Maximum Total Energy Loss Per Pulse Characteristics

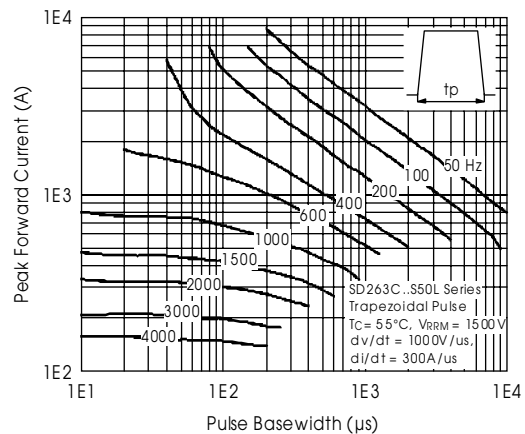

Fig. 18 - Frequency Characteristics

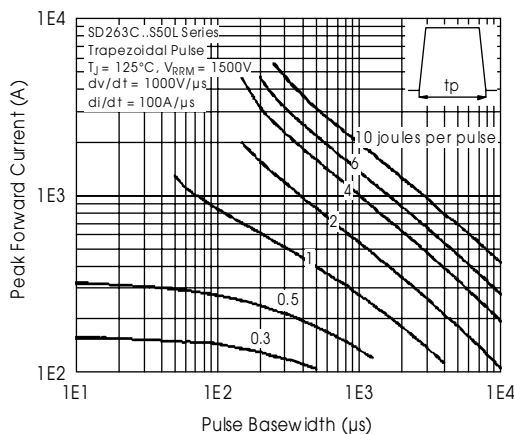

Fig. 19 - Maximum Total Energy Loss Per Pulse Characteristics

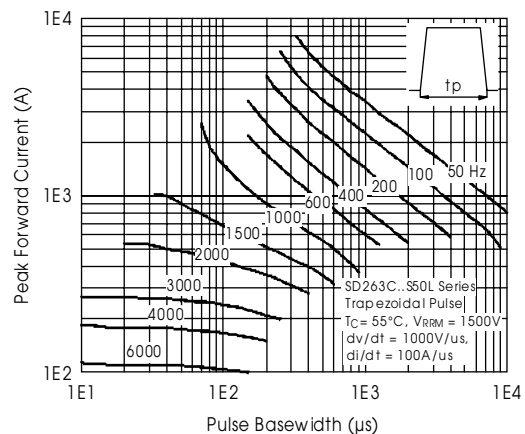

Fig. 20 - Frequency Characteristics